

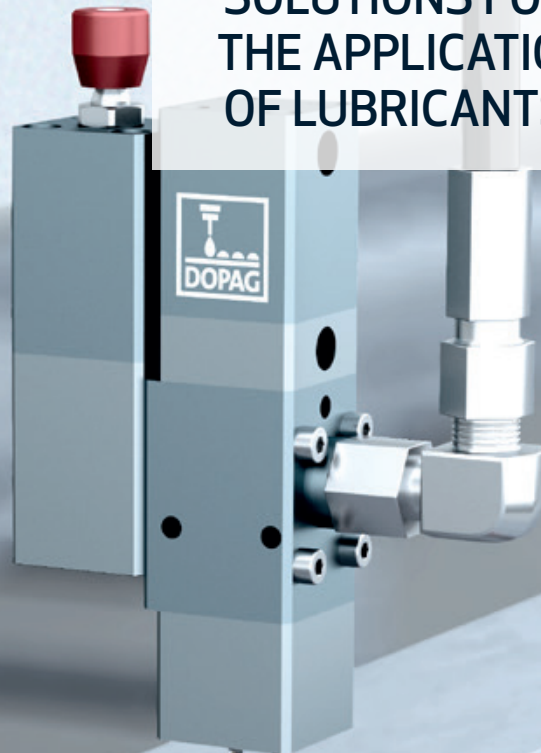

METER · MIX · DISPENSE

lubriLine

SOLUTIONS FOR
THE APPLICATION
OF LUBRICANTS



lubriLine

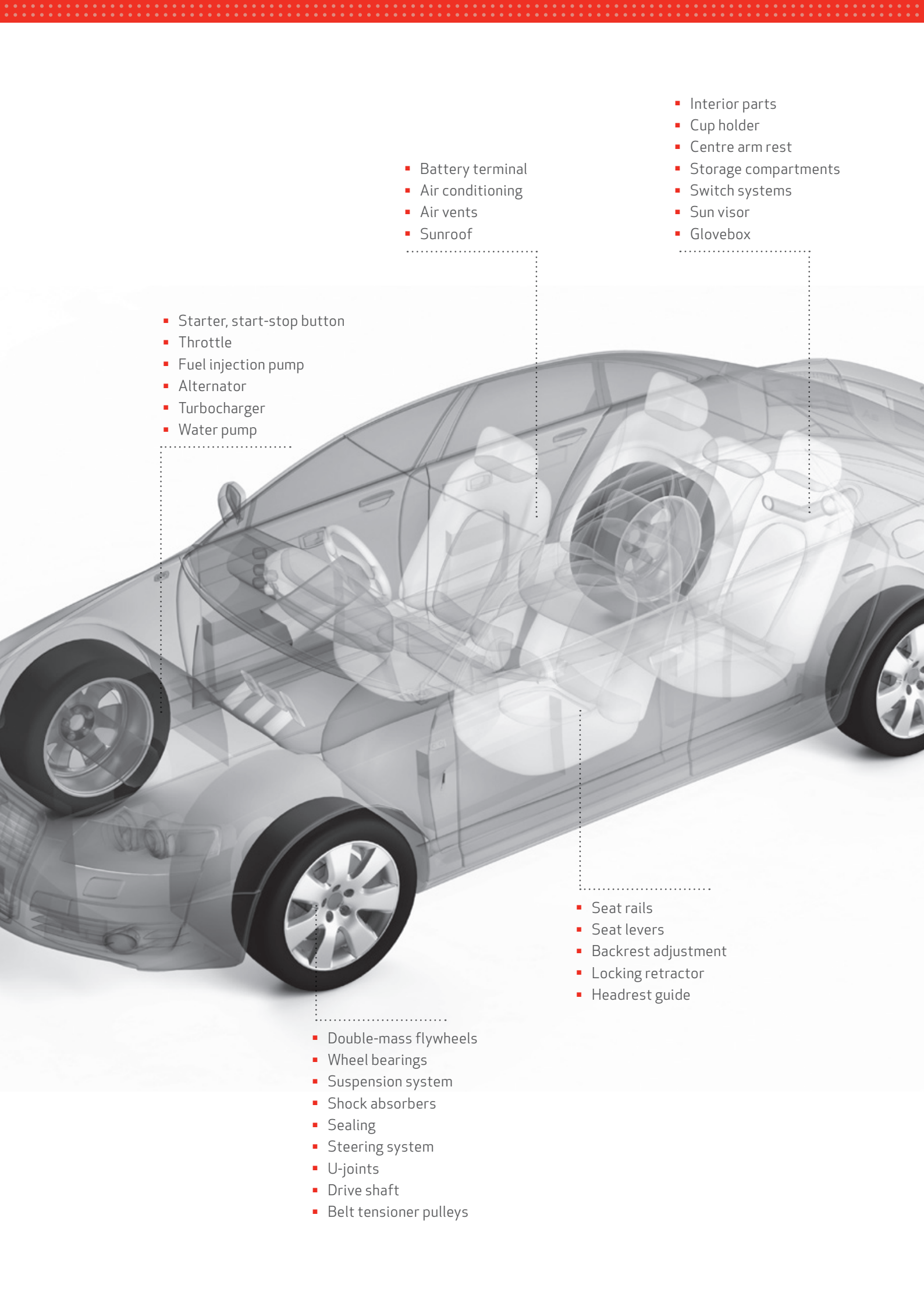

- Battery terminal
- Air conditioning
- Air vents
- Sunroof

- Interior parts
- Cup holder
- Centre arm rest
- Storage compartments
- Switch systems
- Sun visor
- Glovebox

- Starter, start-stop button
- Throttle
- Fuel injection pump
- Alternator
- Turbocharger
- Water pump

- Seat rails
- Seat levers
- Backrest adjustment
- Locking retractor
- Headrest guide

- Double-mass flywheels
- Wheel bearings
- Suspension system
- Shock absorbers
- Sealing
- Steering system
- U-joints
- Drive shaft
- Belt tensioner pulleys

High precision application of lubricants

Every task has a perfect solution

Typically, the production of a single vehicle will involve over 150 grease and oil applications. Depending on the specific car model, there can be even more. The purpose of lubrication is the reduction of friction, noise prevention, component durability and the general smooth running of a vehicle. Each application carries a unique set of parameters and so the designing of a metering system always needs to take numerous factors into account. For example, is the material being applied in a dot, bead or spray form? What is the available time frame for the application? How will the metering system be integrated into the production line? In order to match the specified criteria in each and every case, the following key factors must be carefully analysed and incorporated into the system design:

- Material properties
- Process description
- Temperature
- Control and documentation requirements

Complete and customised solutions from a single provider

A metering system usually consists of three main parts: material feeding, metering and dispensing, and monitoring and control. Depending on the parameters of each case, a metering unit can take various forms: for example, it could be a 1K metering system consisting of multiple components and a dispensing valve or it could be a system with metering valves.

The lubriLine is a selection of products developed by DOPAG to address the specific challenges and needs faced by the automotive industry production. The prime area of use of these products is in highly automated and accurate greasing and oiling processes. Owing to the modular structure of lubriLine, we are able to engineer solutions that are tailored exactly to the parameters of every application. With a wide selection of material feeding systems, valves and process monitoring systems, DOPAG provides everything you need for a smooth and precise fluid metering.

The development of metering systems for lubrication belongs to DOPAG's core areas of expertise since 1976. This places us among the oldest manufacturers on the market, while allowing us to draw on decades' worth of experience. As of 2019, we have worked with more than 160 material manufacturers, having tested over 2,000 materials.

Engineers at the DOPAG Competence Center in Cham (Switzerland) keep exploring the boundaries of metering technology and its applications. Additionally, they have a DOPAG technical center to their disposal, where they test materials and applications during the system conception stage. With eleven subsidiaries and plentiful distributors worldwide, our customers have access to the DOPAG network in more than 40 countries, enjoying the full benefit of excellent local sales and services.

Your project plan

- Customer makes an enquiry
- Enquiry is processed by DOPAG (application form, datasheets, sketch)
- Feasibility study, first layout design, possibly testing in the technical centre
- Budget quotation is made
- Customer reviews budget quotation
- Further testing in collaboration with customer
- Fixed quotation is made
- Customer places an order
- Project engineering / elaboration of detailed configuration
- Production
- Delivery and commissioning

Products for every part of the process

.....



Material feeding 06

Piston pumps	08
Tandem pumps	10
Transfer pumps.....	11
Pressure tanks	12
Material pressure regulators.....	13



Metering & Dispensing..... 14

Needle metering valves.....	16
Chamber metering valves.....	17
Dispensing valves	18
High-speed valves	20
Shot valves.....	21
Spray valves.....	22



Monitoring & Control..... 24

Gear flow meter	26
Metering control unit	27
Micro-flow sensor	28
Light barrier.....	28
Stroke detection.....	29
Pressure sensors	29



Accessories..... 30

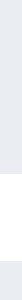
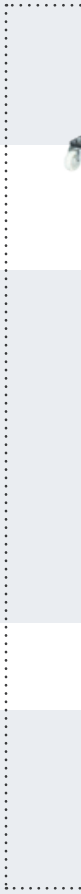
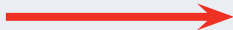
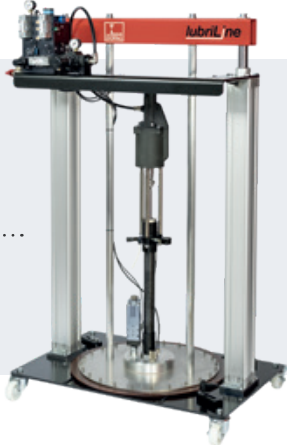

Material feeding

A reliable supply of grease and oil



If we want to achieve perfect results with grease and oil metering, it is important that our material be pumped efficiently and without air pockets (air bubbles). An uninterrupted and reliable material supply is absolutely essential to achieve that. With every application, the selection of an optimum feeding system must consider factors such as material properties, process parameters and container size. The

DOPAG product portfolio offers an extensive range of solutions for fluid metering, including drum pumps, transfer pumps and pressure tanks. All DOPAG feeding systems rely on the proven technology of piston or gear pumps. Moreover, thanks to their modular design, they can be individually configured to match the application and material specifics.

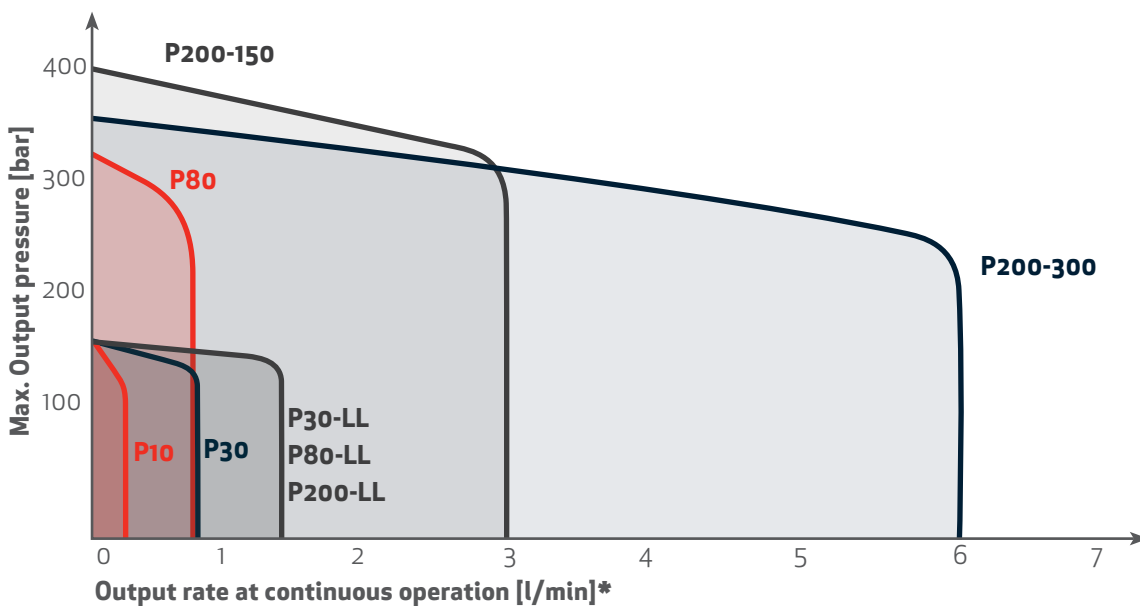
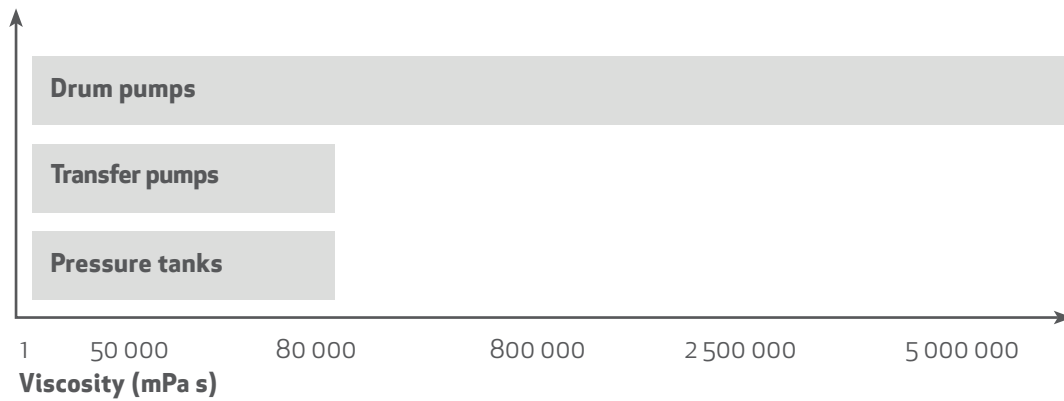

*Short-term increases are possible

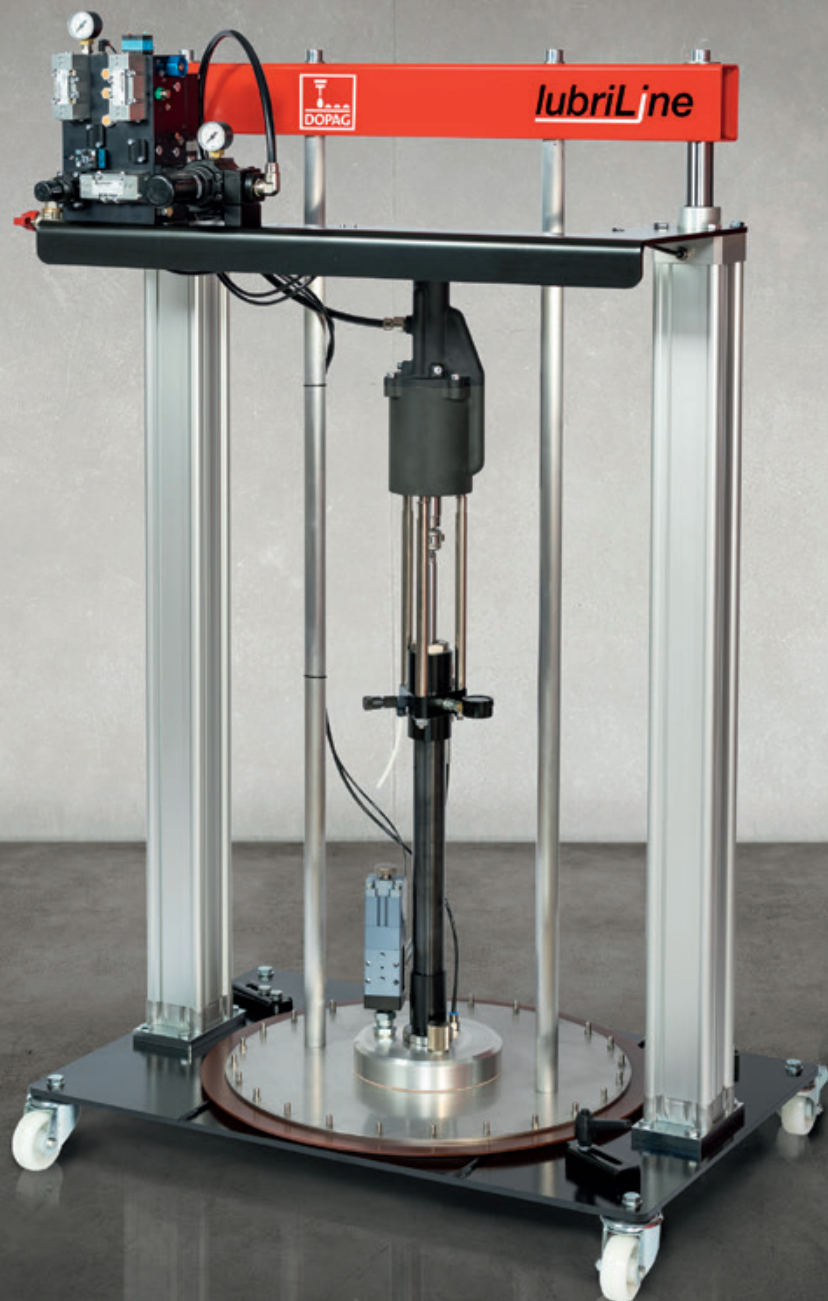

Drum pumps

An efficient supply of lubricants

DOPAG has developed a special range of drum pumps for the processing of lubricants. The lubriLine pump range features double-acting ball valve and piston pumps that deliver greases and oils of consistency class NLGI 0 - 3. Material is fed directly from original containers. LubriLine grease pumps are an ideal option

either as central material supply systems or as single feed stations. While their modularity, robustness and low maintenance requirements make them a valuable addition to any dispensing set up, they are also highly economical, leaving only minimum amounts of material residue in the container.

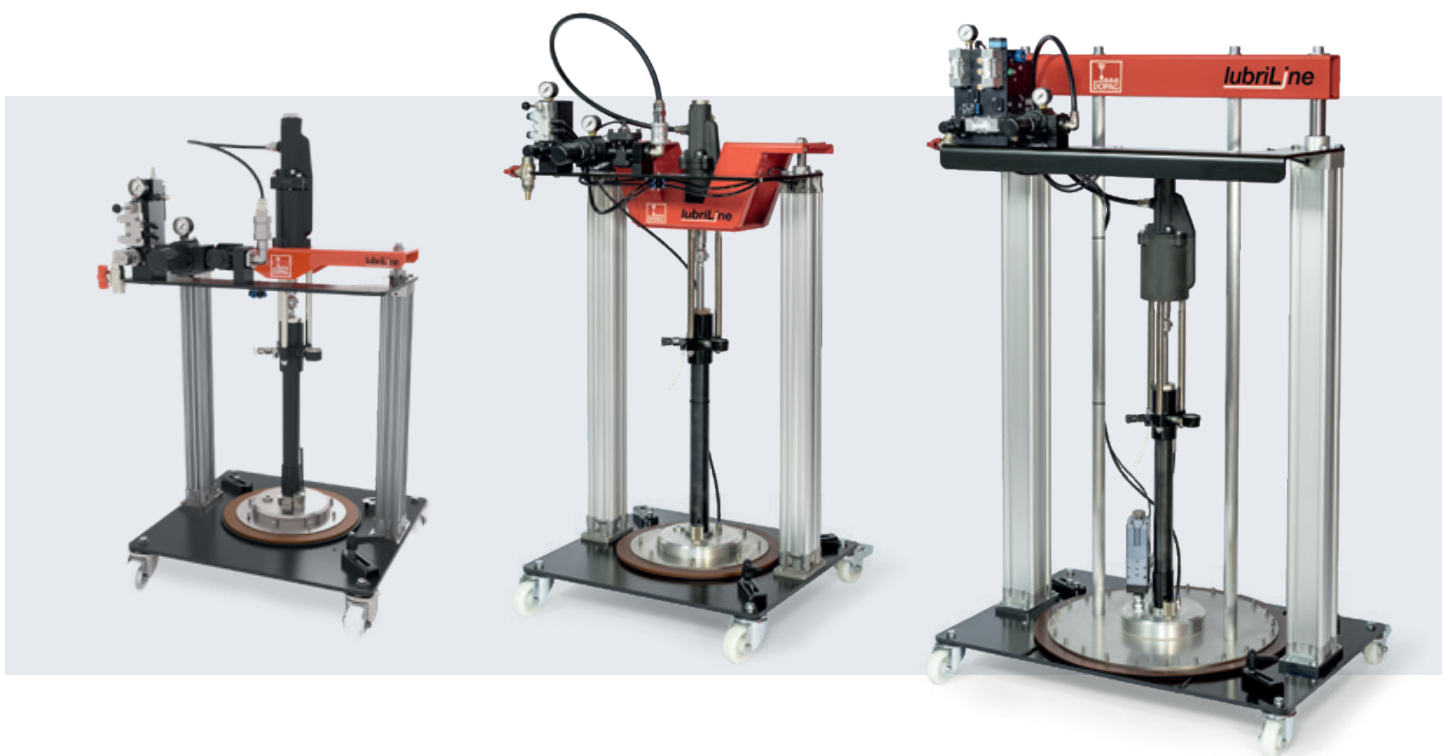

Product features

- Supply of low to medium viscosity materials
- Flow rate up to 1.2 litres/minute at 40 double strokes
- Pressure ratio up to 30:1
- Compatible with lubricants of NLGI class 0 - 3
- Differential piston pumps with fast-switching air motors
- 1- or 2-hand operation
- Modular design with configurable components

Technical data



High performance piston pumps



This drum pump model is available exclusively as a double-acting chop check pump. Along with greases and oils, it also processes adhesives, sealants, polyurethanes or silicones with viscosities of up to 5.0 million mPas. Material is fed directly from the original containers. The piston pump is

ideal for individual station material supply and it serves equally well as a central material supply system. The pumps in this range are modular, robust, economical, extremely reliable and easy to maintain and service.

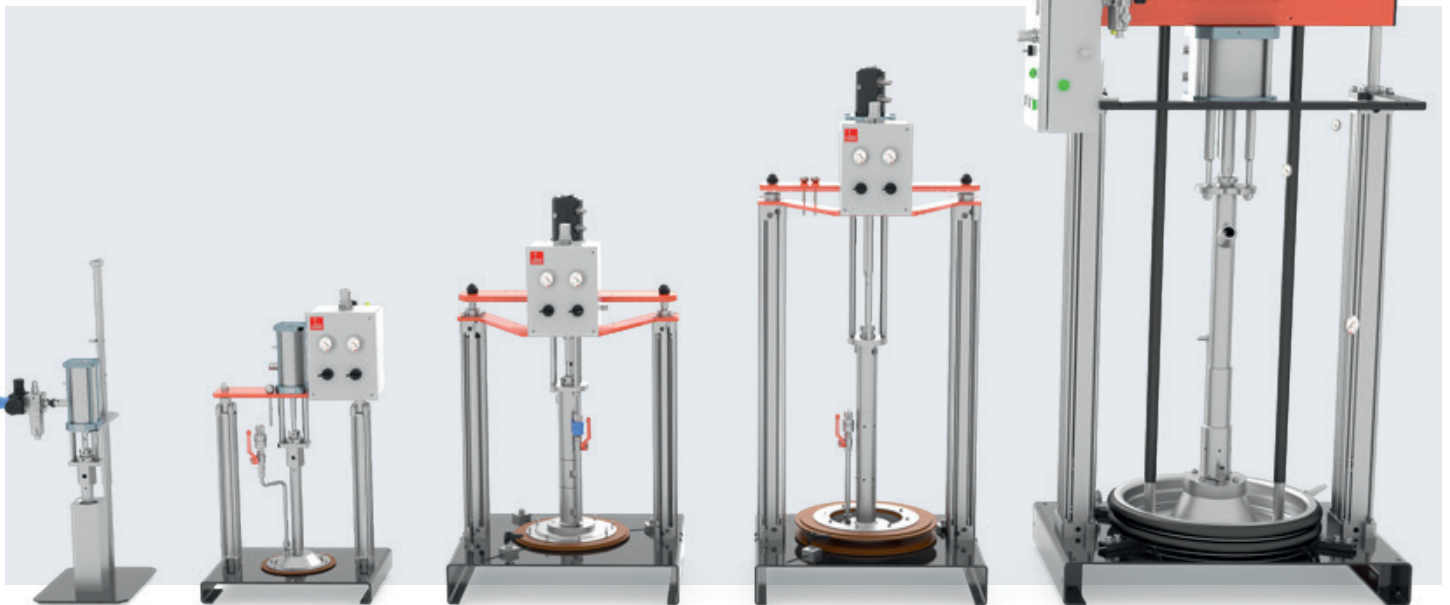

Product features

- Supply of medium to high viscosity material
- Flow rate up to 6 litres/minute at 20 double strokes
- Pressure ratio up to 75:1
- Max. viscosity 5 million mPas
- Differential piston pumps with fast-switching air motors
- 1- or 2-hand operation
- Modular design with configurable components
- Sealing available in various sizes and material finishes

Technical data



Tandem pumps



Many applications require an uninterrupted material feed maintained at all times. For such cases, all DOPAG pump models are available as a tandem version. Tandem pumps feature an automatic mechanism that switches between the pumps whenever material level is low, so that

container change can proceed without interruption and time pressure. With clean handling and minimal material residue left in the drum, DOPAG pumps have earned their place in the most efficient production lines around the world. All sizes are available as tandem versions.



Pump configuration with the ID Generator

Thanks to the modular design of DOPAG drum pumps, customers can combine various modules and features to create a product that perfectly matches their needs. To make this a simple process, we have developed an ID Generator tool, which allows you to configure your pump in a single step and receive its identification code instantly. Using the code, you will be able to order your new pump directly or request a quotation. All you need to know to use the tool are the material properties, drum/ container dimensions and the features you want your new pump to have.

Scan the QR code to create a pump ID or access our ID Generator tool online at:
www.dopag.com/id-generator

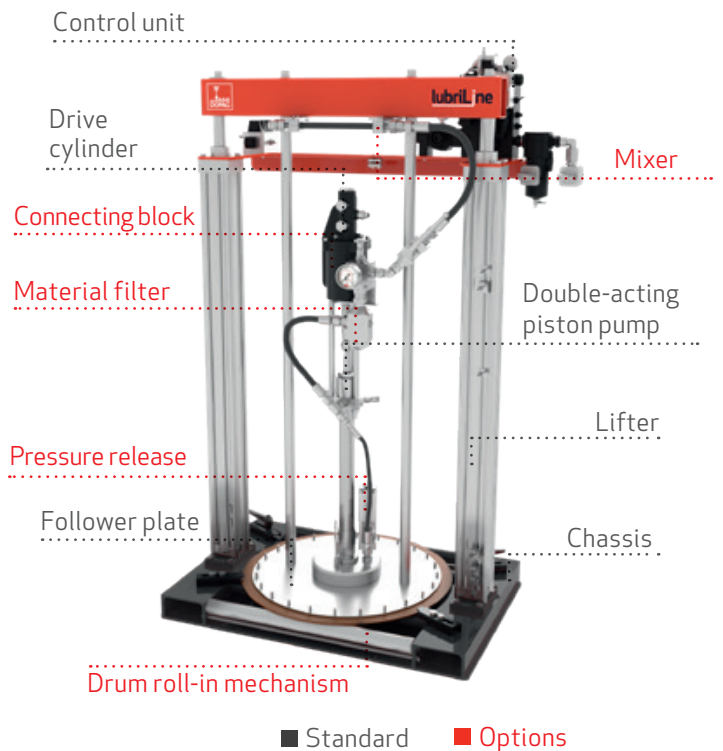

Transfer pumps for direct supply from original containers



Depending on the application type, it may be useful to be able to supply material directly from the original containers using a transfer pump. DOPAG transfer pumps are double-acting pumps with a fast-switching air motor. It should be

noted that the use of transfer pumps is always dependent on the material properties and the container type.



Product features

- Low viscosity material feeding via bung hole
- Flow rate up to 1.0/6.0 litres/minute at 20 double strokes
- Pressure ratio up to 21:1/36:1
- Max. viscosity 80,000 mPas
- Sealing available in various sizes and material finishes

Technical data



Pressure tanks

Thin fluids delivered effortlessly

Low-viscosity media such as oils can be delivered to the point of application directly from pressure tanks by means of compressed air. The tanks can serve either as buffer storage within a metering system or as the main system supply. They are available in various sizes and with options, to accommodate different application

requirements. With visual level indicators and electric level sensors, you will always be aware how much material is left in the tank. Alternatively, DOPAG pressure tanks are also available with mounting fixtures.

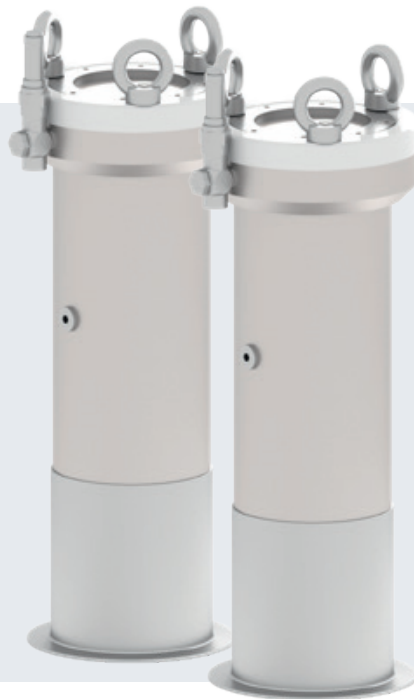

Product features

- For low viscosity media such as paint, oils and preservatives
- Modular construction
- Input pressure max. 6 bar
- Bottom outlet with ball valve
- Max. viscosity 80,000 mPas

Options

- Air maintenance device
- Material filter on outlet
- Agitator
- Fill level sensors
- Heating sleeve
- Gauge glass

Technical data



Material pressure regulators

Pulsation-free dispensing with the correct pressure

DOPAG material pressure regulators reduce the pressure of the pumped material down to the optimum working value. They are designed specifically for the precise dosing of greases, oils and silicones. Along with reducing pressure, the valves also compensate for pulsations that occur when material is delivered via piston pumps, more specifically in the moment of the changeover position of the pump.

This problem manifests itself in fluctuations in material pressure and flow, and can lead to reduced product quality - particularly in cases of very small doses, continuous or spray applications. The material pressure regulator is a guarantee of a perfectly stable material flow. For abrasive or reactive material, we recommend our material pressure regulator with a membrane.



Product features

- Pressure reduction and minimisation of pulsations
- Internal diameter of standard sizes: 4, 8 and 12 mm
- Max. input pressure 250/400 bar
- Max. pressure reduction 1:5
- Outlet pressure depending on model
- Integrated material filter 30 mesh
- Version with membrane available for more challenging applications

Options

- Pressure gauge
- Heating
- Spare filter in different mesh sizes
- Fixing bracket

Technical data



Metering and dispensing

As precise as you need

Metering and dispensing valves from DOPAG demonstrate all the qualities that are essential for optimum results in metering: high precision, excellent reproducibility and high quality standards. The DOPAG range includes various valve types, all of which are based on one of two dispensing principles. The needle and chamber metering valves work on the volumetric principle (dot application). Here, each cycle means that the contents of the valve chamber are

completely emptied upon a trigger signal. This has the advantage of high repetition accuracy and flexibility thanks to the possibility of volume adjustment. On the other hand, dispensing, spray and shot valves work on a different principle, where the discharged quantity is defined by material pressure and valve needle opening time. This allows for application of small quantities from a distance, as well as continuous applications of any material amount.

Contact application



Dot application



Continuous application



Shot application



Spray application

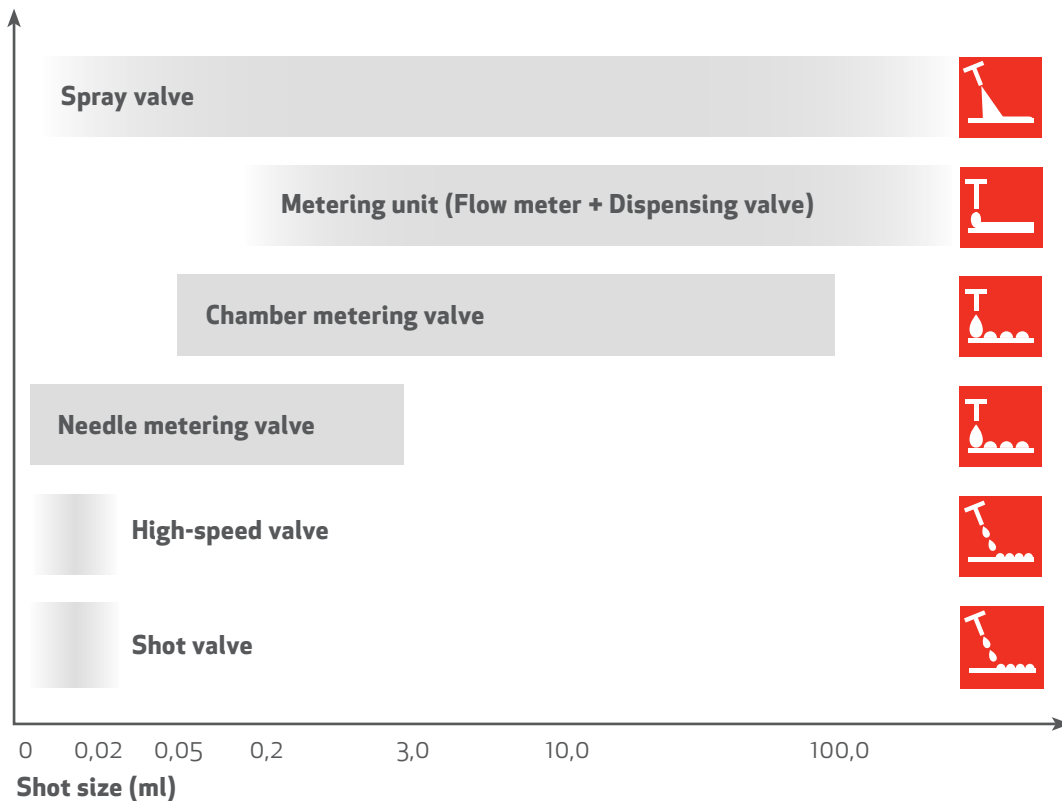



Needle metering valves

Greater accuracy for small dot size



Needle metering valves are suitable for dot application of low to high viscosity media. With this series, very small quantities of up to 3ml per shot can be discharged with high reproducibility and short cycle times.

The valve consists of two structurally separate parts, meaning that material cannot leak into the drive cylinder and interfere with the movement of the valve needle. This feature makes the needle metering valve an exceptionally

reliable and low-maintenance piece of metering equipment. Shot size is determined by the volume of the valve chamber, which can be adjusted within a predetermined range using a stop screw. The metering cycle can be controlled either pneumatically or electrically via a solenoid valve. DOPAG needle metering valves are perfectly suitable for manual applications with a handle as well as for fully automated processes.

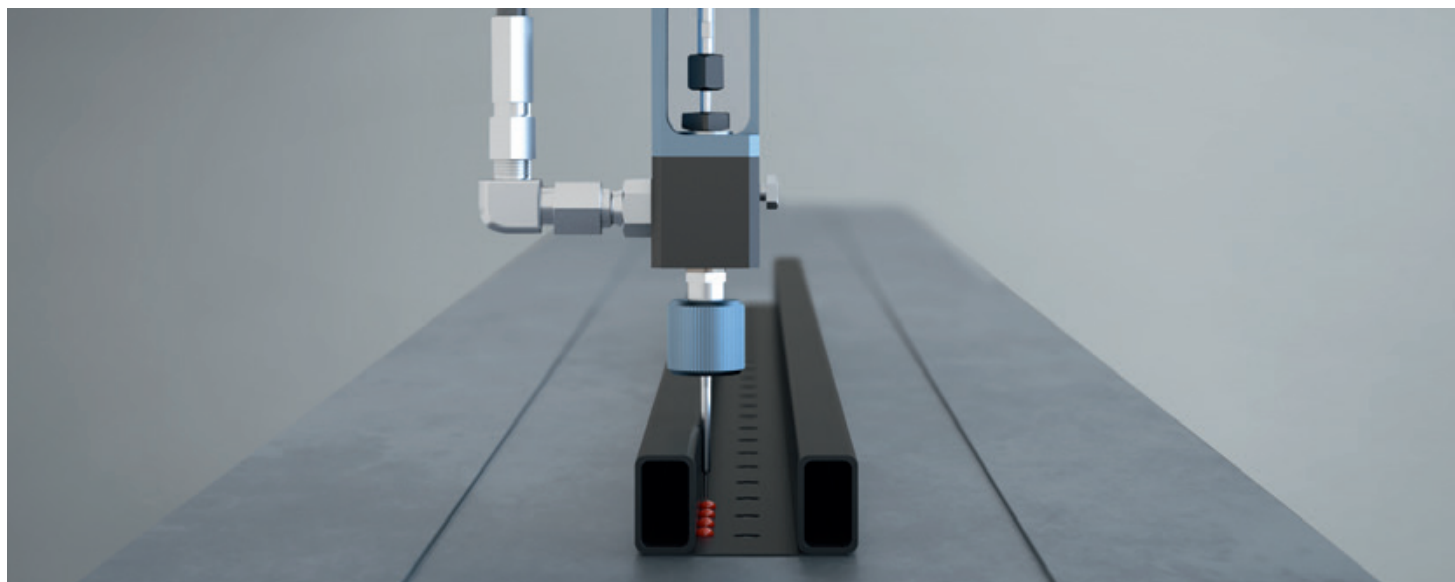

Product features

- Dot application (volumetric dispensing)
- Shot size 0.001 - 3.00 ml (depending on model)
- Material input pressure 3 - 50 bar
- Compatible with stroke detection (see p. 29)
- Sealing available in various sizes and material finishes

Options

- Solenoid valve plate 24 V
- Signal generator with various cables
- Various adapters and needle tips
- Micro-flow sensor (see p. 28)
- Pneumatic or electric handle

Technical data



Chamber metering valves

Process stability and shot size flexibility



Chamber metering valves are used for dot application of low to high viscosity media. Compared to the needle metering valve, they offer a larger range of shot sizes. Thanks to an innovative design that features a 'snuff back' effect, these valves are characteristic for their high process stability and drip-free application when dispensing low-viscosity media. The shot size is determined by the chamber volume,

which can be adjusted within a predetermined range using a stop screw. The metering cycle is controlled either pneumatically or electrically via a solenoid valve. This valve series allows a highly repeatable metering of small quantities up to 100 ml within short cycle times. Manual application with a handle is just as possible as the integration into a fully automated process.

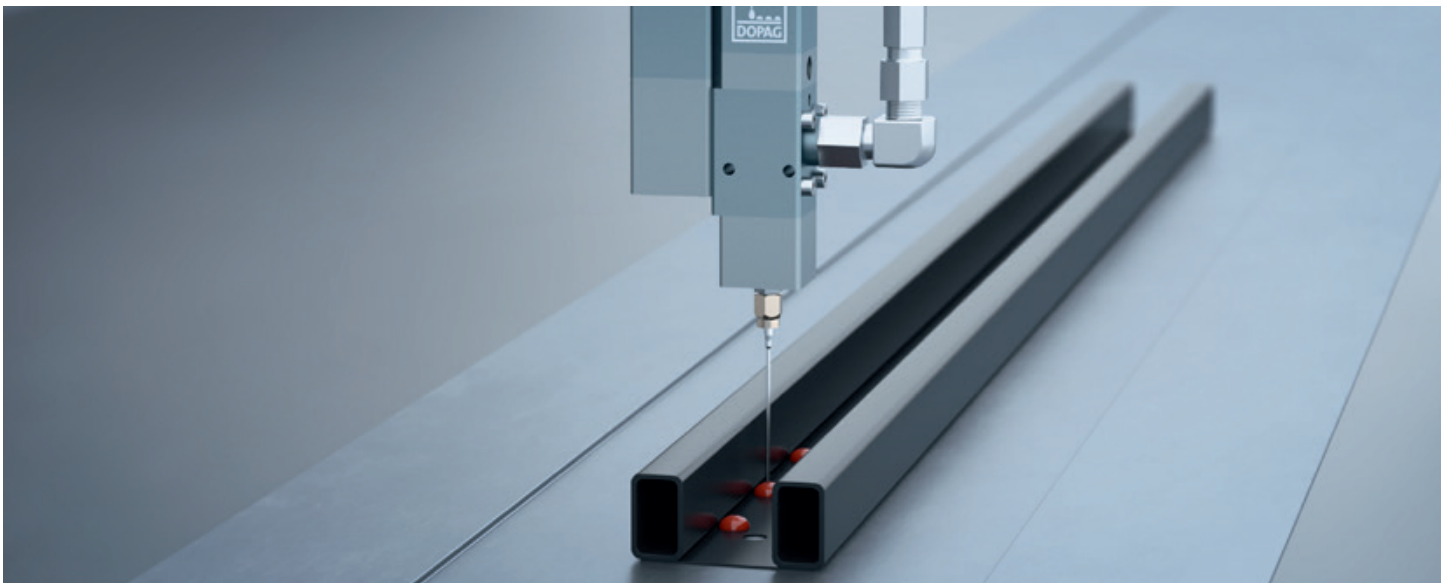

Product features

- Dot application (volumetric metering)
- Shot size 0.05 - 100.00 ml (depending on model)
- Material input pressure 40 - 80 bar
- Compatible with stroke detection (see p. 29)
- Snuff-back effect

Options

- Solenoid valve plate 24 V
- Signal generator with various cables
- Various adapters and needle tips
- Pneumatic or electric handle

Technical data



Needle dispensing valves

Continuous dispensing with great flexibility

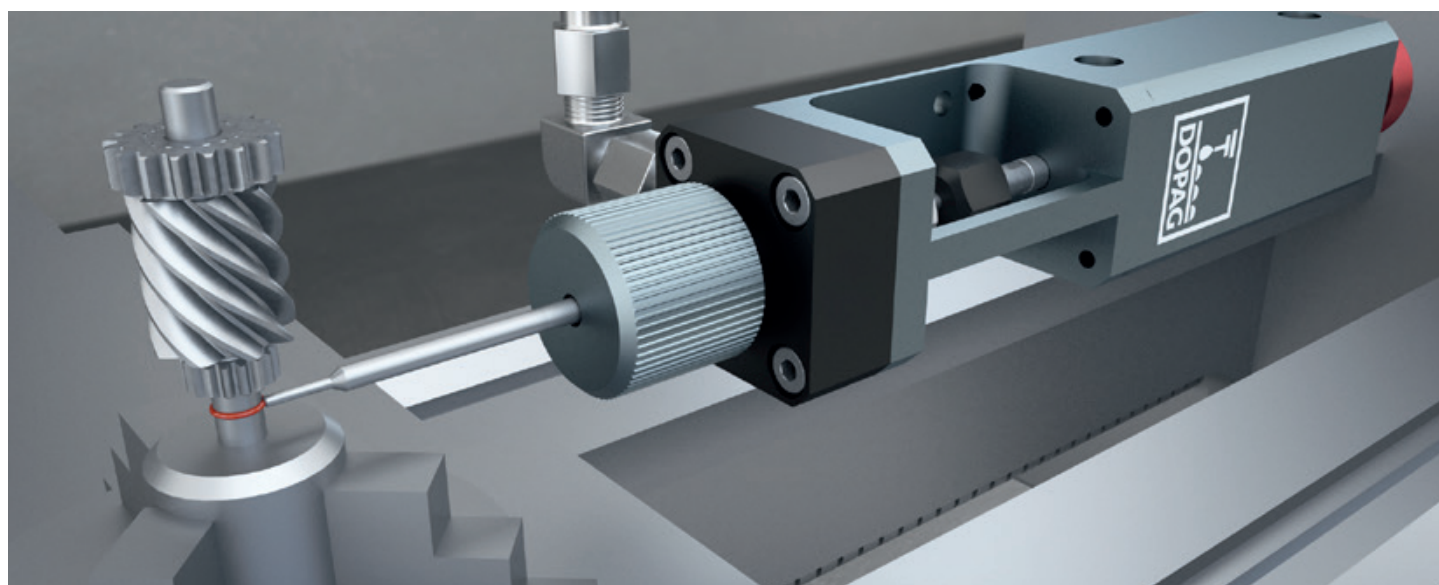

Product features

- Continuous application (time-pressure dispensing)
- Internal diameter 1, 2.5, 6 and 12 mm
- Max. input pressure 250 bar
- Compatible with stroke detection (see p. 29)
- Sealing available in various sizes and material finishes

Options

- Solenoid valve plate 24 V
- Signal generator with various cables
- Various adapters and needle tips
- Pneumatic or electric handle

Technical data



Membrane dispensing valves

Clever solutions to the greatest challenges



The advantage of membrane dispensing valves is their ability to process material with challenging properties in continuous shot applications. The valves are designed for care-free dispensing of low to high viscosity, filled or unfilled, abrasive or chemically reactive 1K fluids. Part of their structure is an integrated membrane that

separates the pneumatic and the metering parts of the valve. As a result, only the valve head and the membrane come in contact with the material, while the material passageway can be easily flushed if necessary. The size of the orifice is regulated by stroke adjustment. Material dripping after shot completion is effectively prevented by the snuff-back mechanism. This valve is exceptionally easy on maintenance.

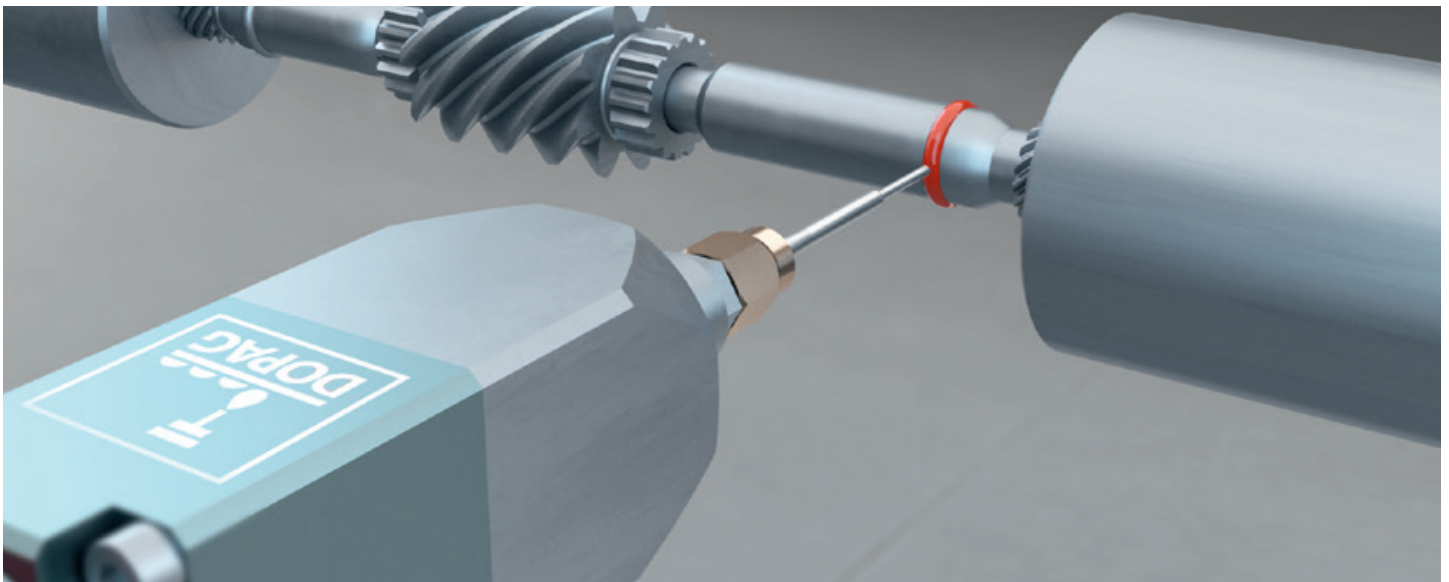

Product features

- Continuous application (time-pressure dispensing)
- Internal diameter 2, 4 and 8 mm
- Max. input pressure 160 bar
- Snuff-back effect

Options

- Solenoid valve plate 24 V
- Various adapters and needle tips
- Pneumatic or electric handle
- Heated valve with or without plug 230 V AC / 200W

Technical data



High-speed valves

Contactless greasing in automated processes



The high-speed valve is used in contactless (from a distance) applications of grease and oil where stringing must be avoided. The compact design of the valve enables an effortless and effective greasing of narrow and hard-to-reach spaces. The dot application takes place in the longitudinal direction of the nozzle with a perfect

material cut off after each shot. With short cycle times, this valve is ideal for integration into highly efficient processes. Thanks to an innovative nozzle with a self-cleaning effect and an integrated filter, the high-speed valve delivers a perfectly clean application every time. An integrated heating element keeps the material properties at their optimum, ensuring high process stability and reproducibility.

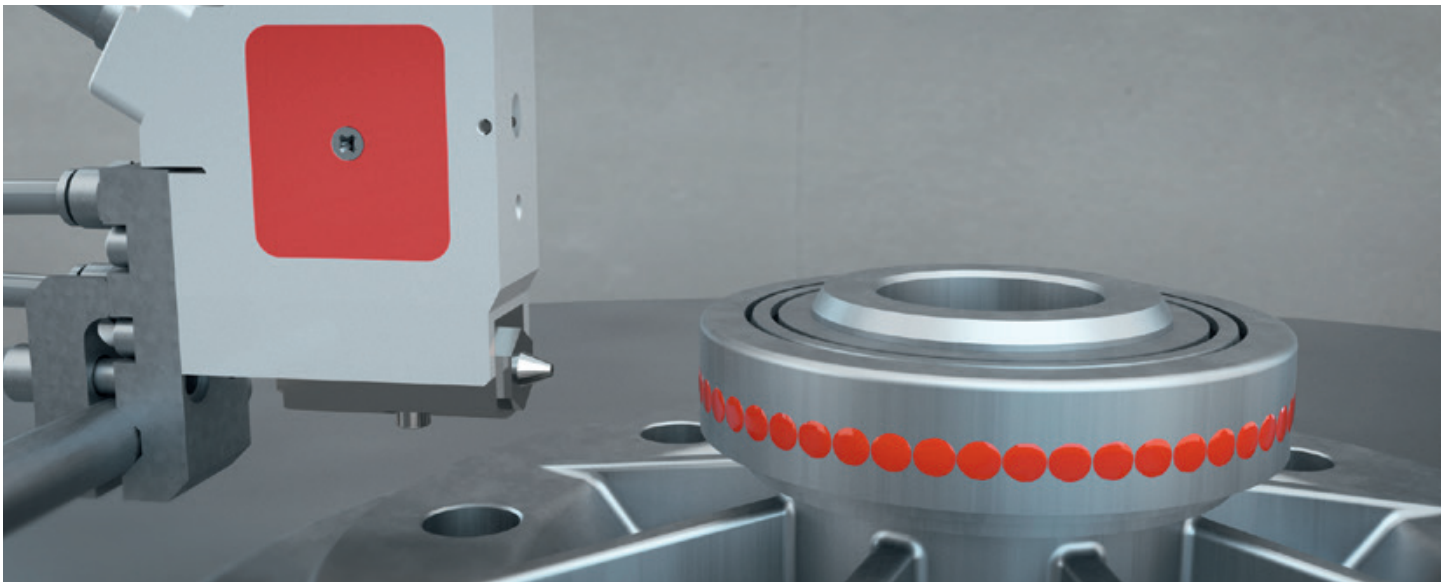

Product features

- Shot application
- Nozzle size \varnothing 0.21 – 0.81 mm
- Input pressure max. 70 bar
- 24V DC solenoid valve for maximum shot frequency of 100 Hz
- Integrated 230 V AC / 155 W heating with a temperature sensor PT100

Options

- 5m cable for heating
- Light barrier for shot detection (see p. 28)

Technical data



Shot valves

Lubrication of hard-to-reach places in automated processes



Shot valves are extremely fast-switching valves designed for the application of grease and oil from distance (contactless) in automated processes. They are capable of dispensing the smallest amounts of material at the speed of up to 200 cycles per second. This is possible thanks to the integrated 5/2 way solenoid

valve (also used for control), together with short paths in the entire air supply system. The valves are available with both short and long nozzles, which enables them to cover various angles of application. Depending on the nozzle size, media with different viscosities can be processed easily.

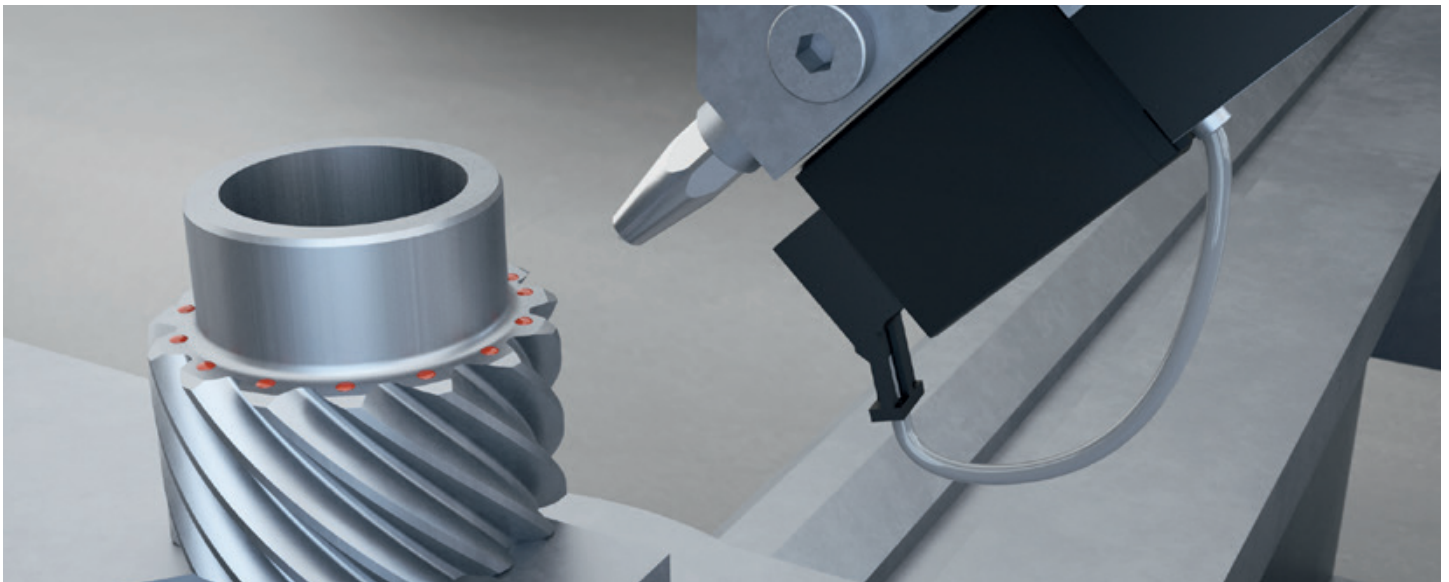

Product features

- Shot application
- Nozzle size \varnothing 0.2 - 1.0 mm
- Input pressure max. 100 bar
- 24 V DC solenoid valve for maximum shot frequency 200 Hz SHV-01 / 30 Hz SHV-02
- Adjustable needle rise (raster regulation)

Options

- Stroke detection device with cable (see p. 29)
- Nozzle extensions with various lengths and shot angles
- 24 V / 50 W heating with temperature sensor PT100
- Pressure sensor (see p. 29)
- Light barrier for shot detection (see p. 28)

Technical data



Spray valves

Full surface coverage applied from a distance



The spray valve is a special kind of valve designed for full-surface application of greases and oils. It is suitable for both intermittent and continuous material applications. A unique feature of this valve is the integration of a membrane, which is used for the adjustment of the air blow duration after each material

shot - this serves the cleaning of the nozzle. Short air ways in the body of the valve and a flange-mounted 5/2 way solenoid valve allow a very fast and accurate intermittent operation. A wide range of available extensions and attachments open up the possibility of spray application in hard-to-access areas, while various aircaps allow the customisation of the spray coating pattern.

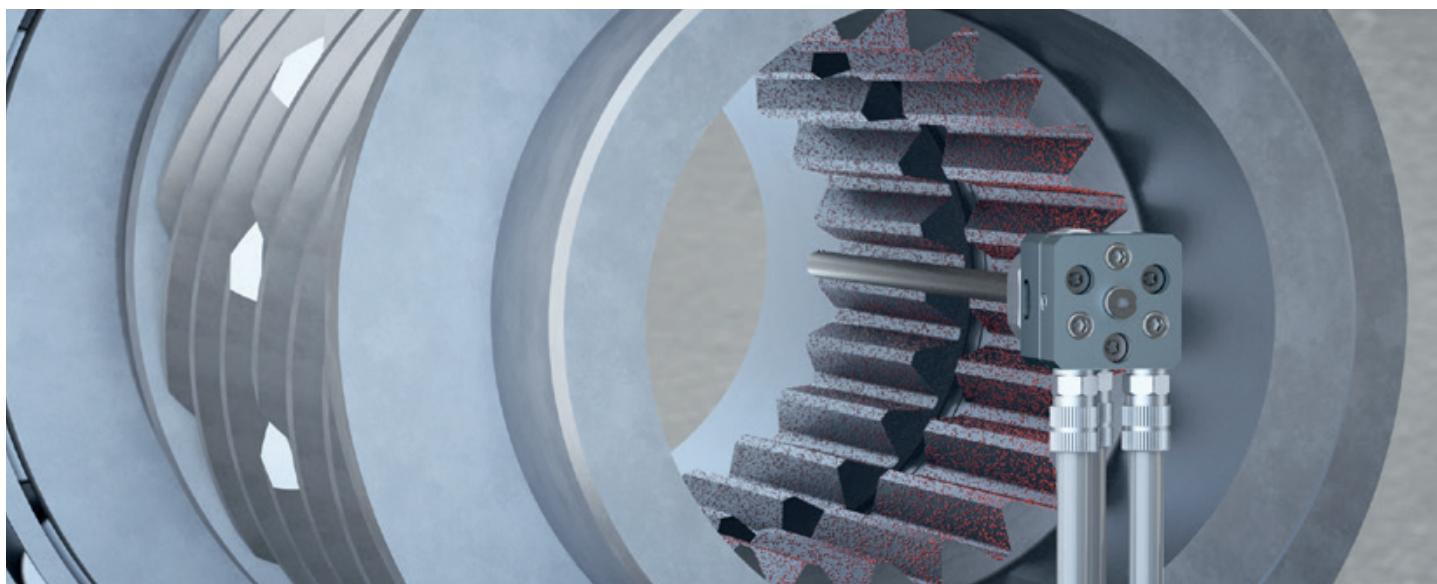

Product features

- Spray application
- Nozzle size \varnothing 0.2 - 1.5 mm
- Material input pressure max. 35 bar
- With 24 V solenoid valve (SPV-01) / Compact construction without solenoid valve (SPV-02)

Options

- Stroke detection with cable (see p. 29)
- Various nozzle extensions with different spray cones and angles
- 24 V/50 W heating with temperature sensor PT100
- Pressure sensor (see p. 29)

Technical data



Spray guns

A perfectly clean application by hand



In cases, where manual, full-surface application of greases and oils is required, DOPAG offers a spray gun. The spray gun can process oils without fillers in the viscosity range of up to approx. 100,000 mPas, as well as unfilled greases of consistency

class NLGI 0-3. A variety of nozzle sizes, air caps and extensions offers a high degree of flexibility, allowing the user to apply material reliably even onto hard-to-reach areas. Lastly, the gun is very easy and quick to handle, owing to its user-friendly design.

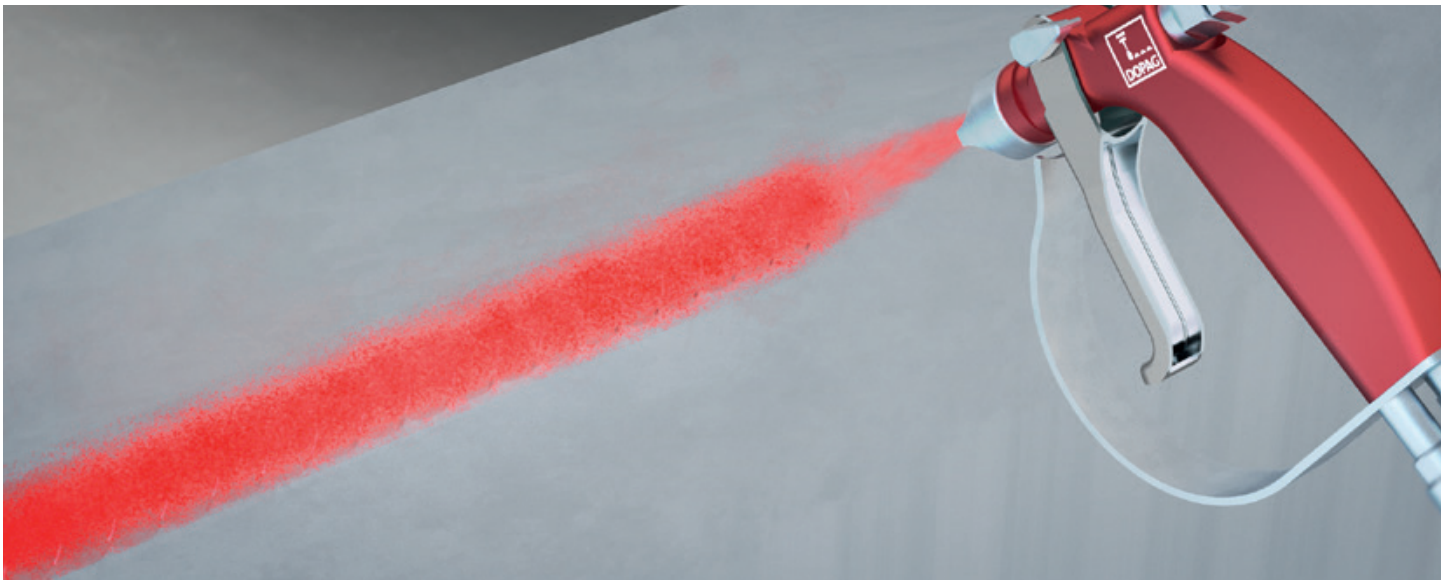

Product features

- Manual spray application
- Nozzle size \varnothing 0.2 - 1.5 mm
- Material input pressure max. 50 bar
- Pneumatic pressure max. 6 bar

Options

- Various nozzle extensions with different spray cones and angles

Technical data



Monitoring and control

Process-stable and reproducible metering

Metering processes are generally defined by short cycles, high repetition rates and strictly given tolerances. Moreover, the shots being applied are often only minuscule amounts of material, in which case it is all the more important that the metering be reliable, accurate and reproducible. Modern production processes require a detailed monitoring of the process capability and the repeatability of applications. These requirements must be carefully defined right at the start and considered in the system

concept design. DOPAG offers a comprehensive portfolio of process monitoring and control technology, including gear flow metering cells, light barriers, pressure sensors and metering control units. System concept designing at DOPAG involves our engineers working closely with the customer to align process control and monitoring mechanisms with the application requirements, and combining them with the appropriate pumps and metering components.

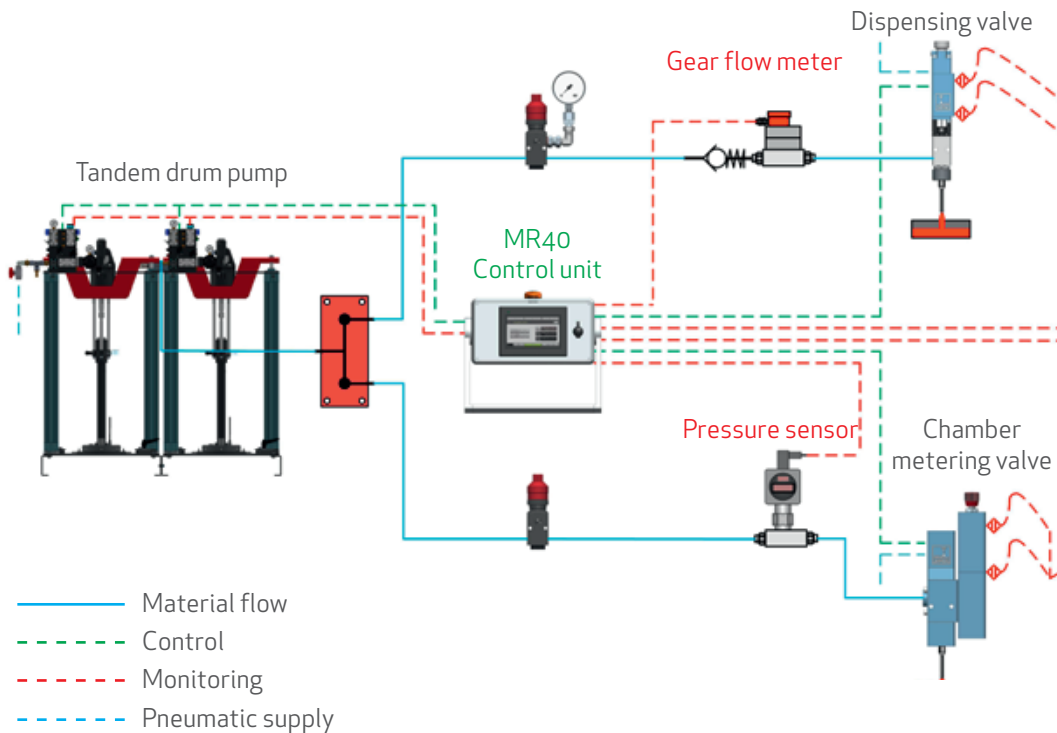

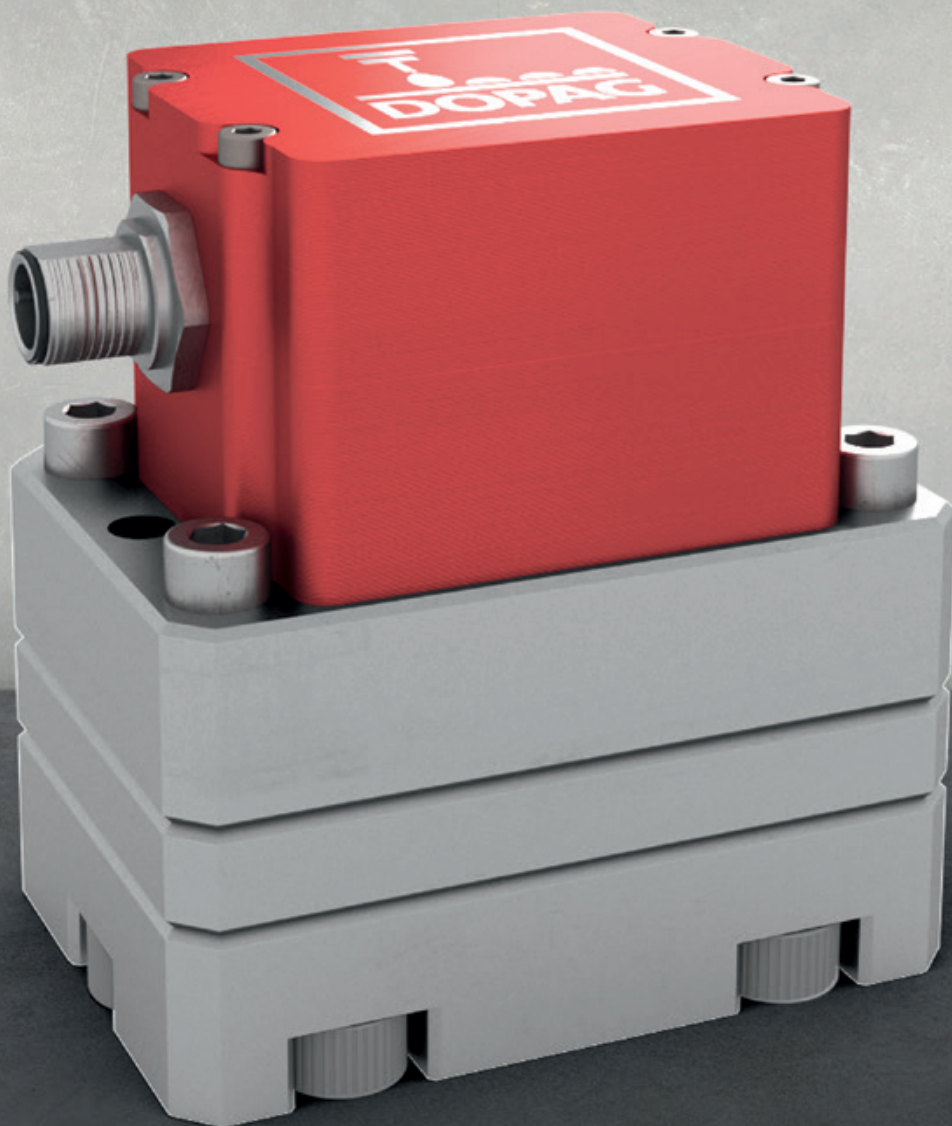

Gear flow meter

Precise monitoring and control of the metering process

The DOPAG gear flow meter has been developed specifically for use in DOPAG metering and mixing systems. In processes involving one-part media such as greases and oils, it is used for measuring the exact material flow rate at any given moment. The measuring principle is based on the volumetric gear displacement system, characteristic for its accuracy and compressive strength. The measuring element comprises of a very

precisely fitted pair of gears placed in the housing of the flow meter. The rotation of the measuring element is detected by a contactless sensor system and converted into digital signals. A metering unit containing a gear-based flow meter combined with a flow-regulating and dispensing valve is ideal for an accurate dispensing or filling of larger quantities of fluids.



Product features

- Monitoring and control of metering processes
- Stainless steel and aluminium housing
- Pulse multiplication max. 16-fold
- Gear volume 0.04/0.2/0.4/2 cm³
- Plain or ball bearing version available

Options

- Sensors
- Different connections and adaptors
- Heated connection plate
- Connecting cable

Technical data



Metering control unit

Connect and control your metering components

The MR40 is a control unit developed by DOPAG for the control of complex metering processes. It can be easily integrated into a system with a metering valve or into a 1K metering system with dispensing valves. The control unit enables communication between individual system components and coordinates their operation. Additionally, the featured software allows users to store numerous

metering programmes and to recall and run them later. The control unit is equipped with connection ports for various material supply systems and is compatible with monitoring devices such as the gear flow meter or the light barrier. It can be used either as system control or as an interface between a higher-level system control and a metering system.



Product features

- Power supply 230 VAC 50 / 60 Hz
- 7" Touch screen control panel
- USB interface for programme updates
- Indicator light with buzzer for error messages

Housing

- Plastic benchtop housing, 370 x 330 x 200 mm with positioning frame
- Sheet metal wall housing 400 x 400 x 210 mm, with fixing brackets

Options

- Profibus, Profinet or Ethernet IP module
- Different connection and heating cables
- Screen protection foil

Technical data



Micro-flow sensor



The micro-flow sensor can be used with needle metering valves to confirm that material is being dispensed. It is designed for the detection of very small quantities (0.005 - 3.00 ml). This device is meant purely for material discharge monitoring purposes, not as a means of volumetric measurement.

Compatible with:

- Needle metering valves (p. 16)



Technical data



Light barrier



The light barrier is a process monitoring device used with the very fast-switching shot and high-speed valves. It counts the number of discharged shots, checking them against the set target quantity.

Compatible with:

- High-speed valves (p. 20)
- Shot valve SHV-01 (p. 21)

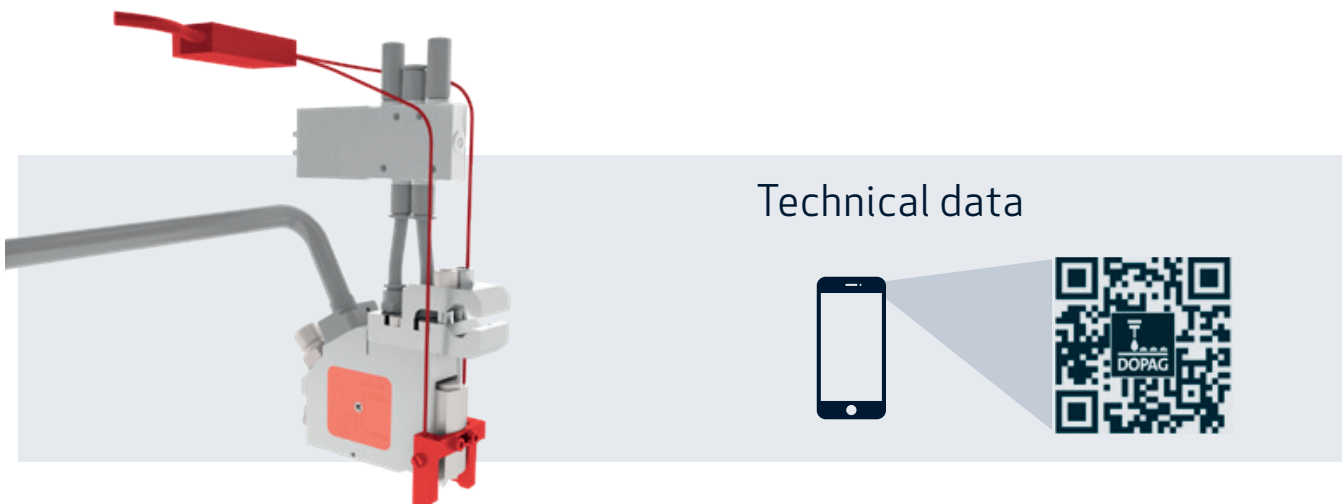

Technical data

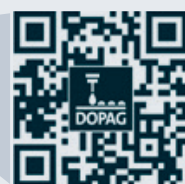
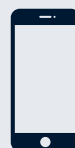

Stroke detection

The stroke detection device monitors the correct activity of various valve types. Detecting the upstroke movement of the dispensing needle or the metering piston, it sends signals to indicate the proper functioning of a valve.

Compatible with:

- Needle metering valves (p. 16)
- Chamber metering valves (p.17)
- Needle dispensing valves (p. 18)
- Shot valves (p. 21)
- Spray valves (p. 22)

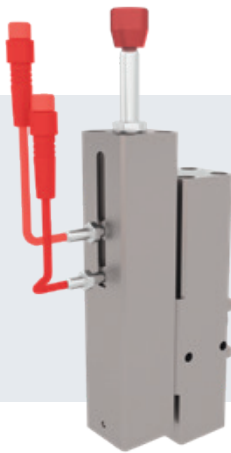

Technical data



Pressure sensors

Pressure sensors can be firmly mounted on shot and spray valves or they can be positioned further up in the system. They indicate the current material pressure or transmit it over to a monitoring unit.

Compatible with:

- Shot valves (p. 21)
- Spray valves (p. 22)
- Integration into a system (digital/analogue)



Technical data

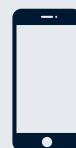

Accessories

Everything you need to build a perfect system

DOPAG pumps and metering components are complemented by an extensive range of accessories to create a complete metering system. Our technicians will be happy to assist you in selecting the right equipment for your needs:

- Multipliers
- Heated hoses
- Pneumatic tubing
- Hydraulic tubing
- Pressure gauges
- Material filters
- Mixer tubes
- Check valves
- Adapters

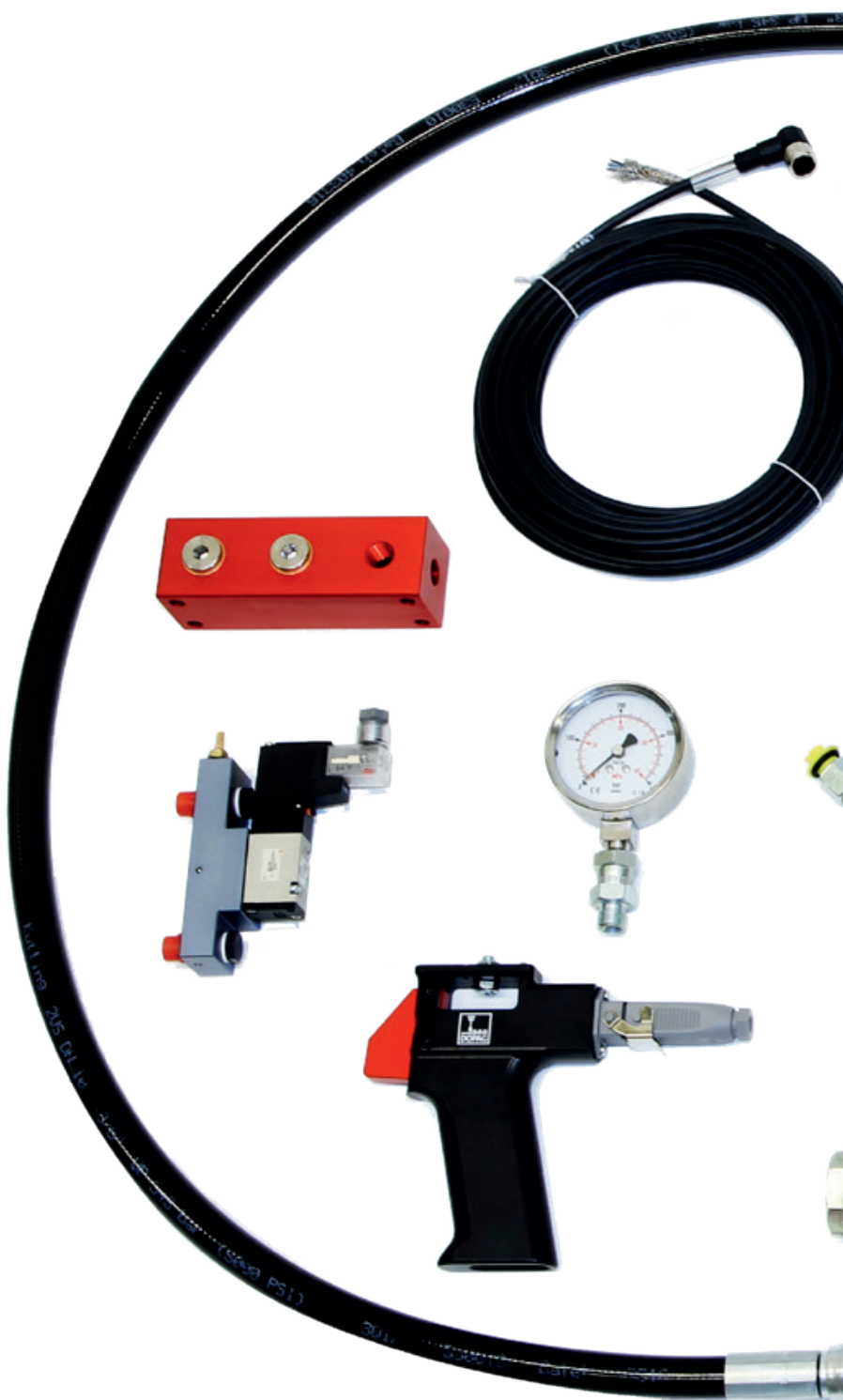

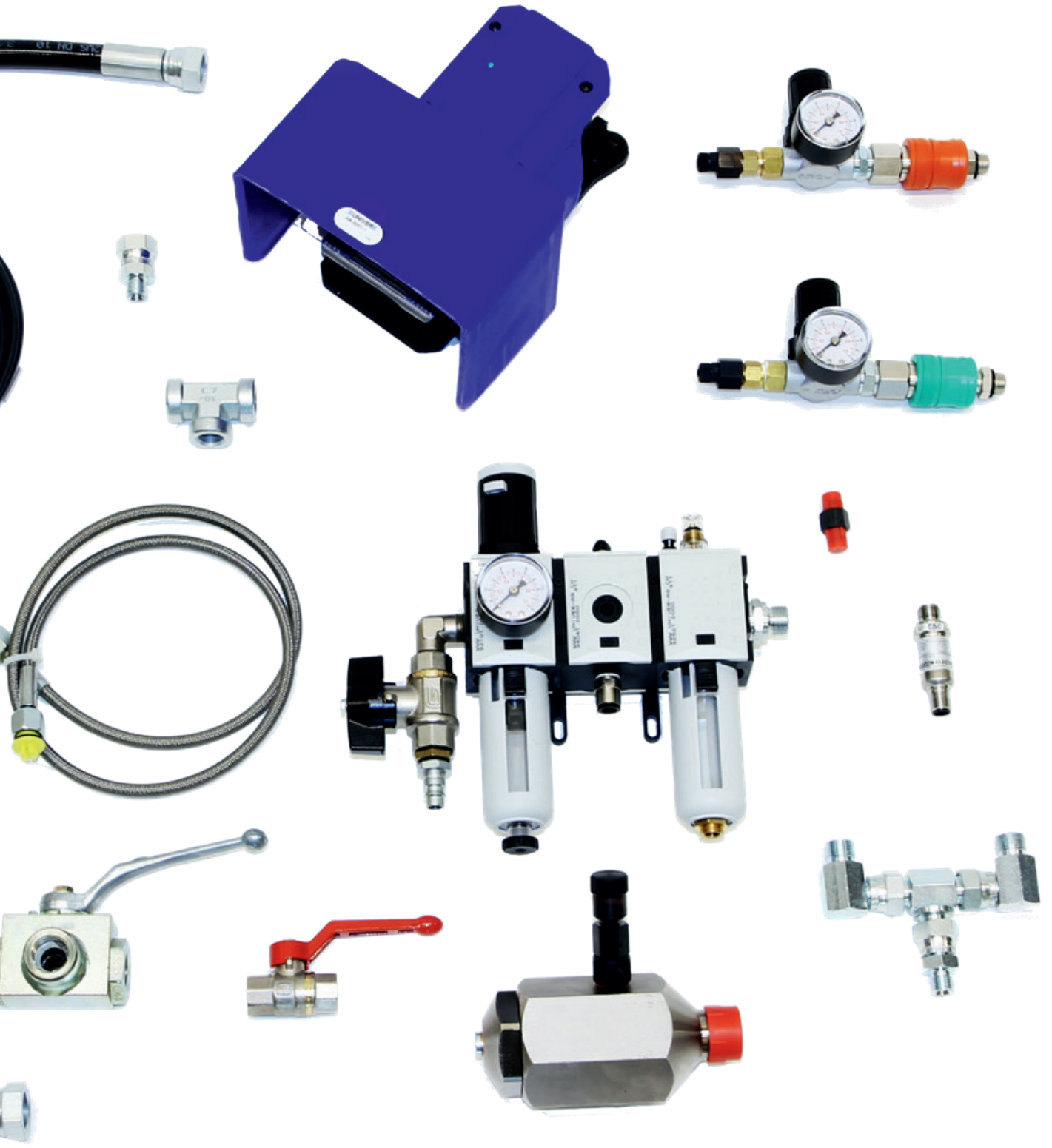



We are one of the world's most experienced manufacturers of high-quality metering technology. Wherever adhesives, resins, silicones or lubricants are metered and applied in industrial production, we offer reliable, precise solutions. We provide systems and components for highly automated production processes, including for the automotive, wind, household appliances and electrical industries, as well as for aviation and space travel.

DOPAG is part of the HILGER & KERN GROUP, a reliable supplier, development and service partner to industrial companies in a variety of market segments for over 90 years. The group employs around 350 people and has subsidiaries and distributors in more than 40 countries.

Worldwide sales and service

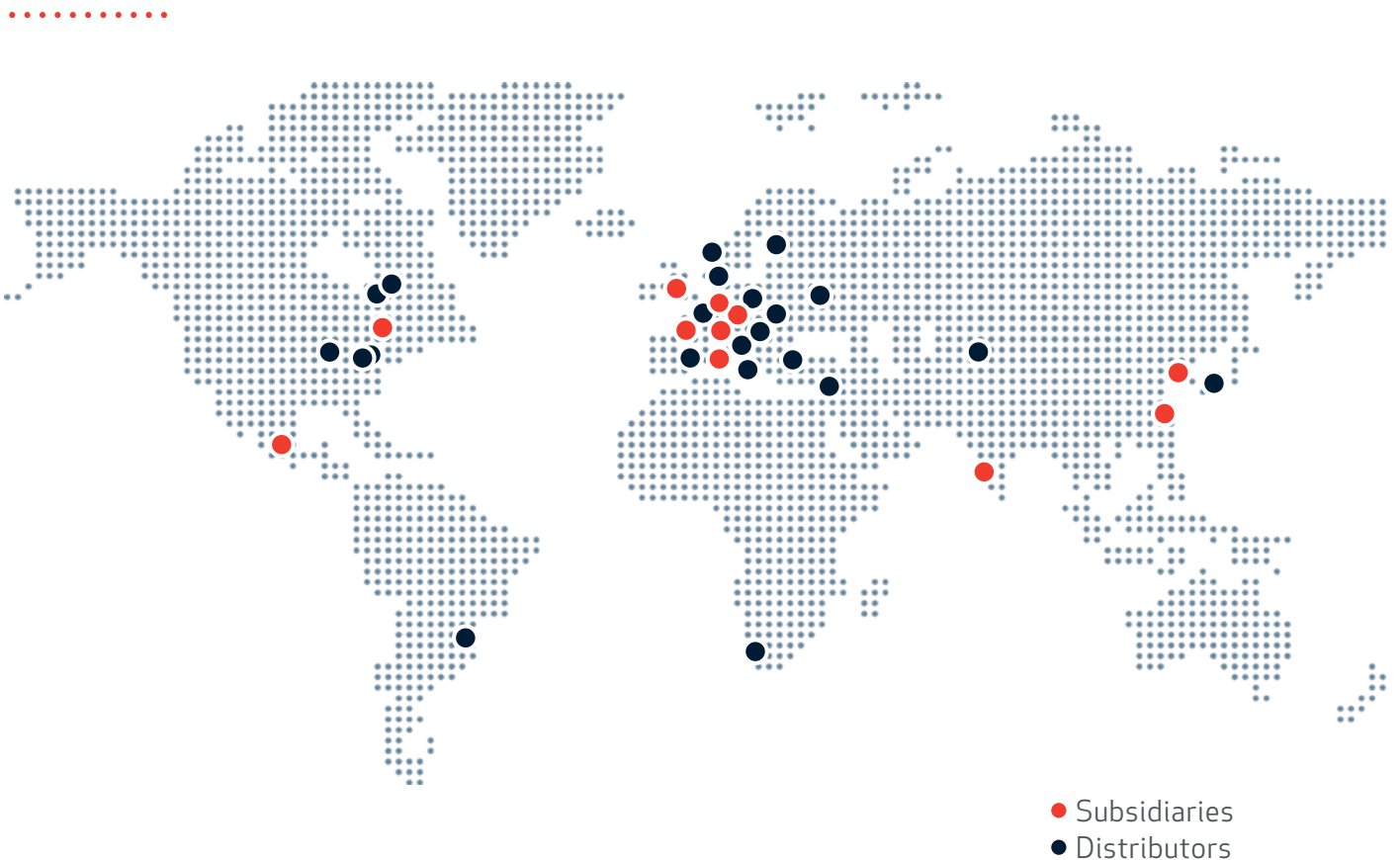

Please find your local DOPAG contact here:
www.dopag.com/contacts

